

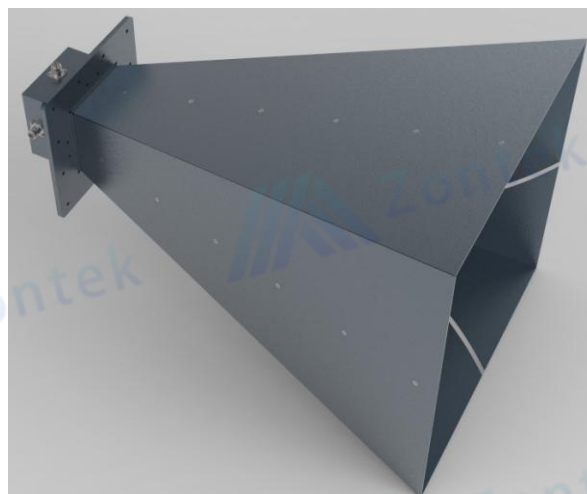

Technical Specification		
Dual Polarization Horn Antenna		
Item	Specification	Unit
Model	ZK-SJLB0730	
Frequency Range	0.7-3	GHz
Gain	$\geq 10$	dB
VSWR	1.5 Typ.	
Polarization	Dual Linear	
Connector	N-50K	
Power Handing(W)	50 Max	
Material	Al	
Color	Grey	
Size	790*503*503	mm





# Chengdu Zontek Technology Co.,Ltd.

Outline Drawing:

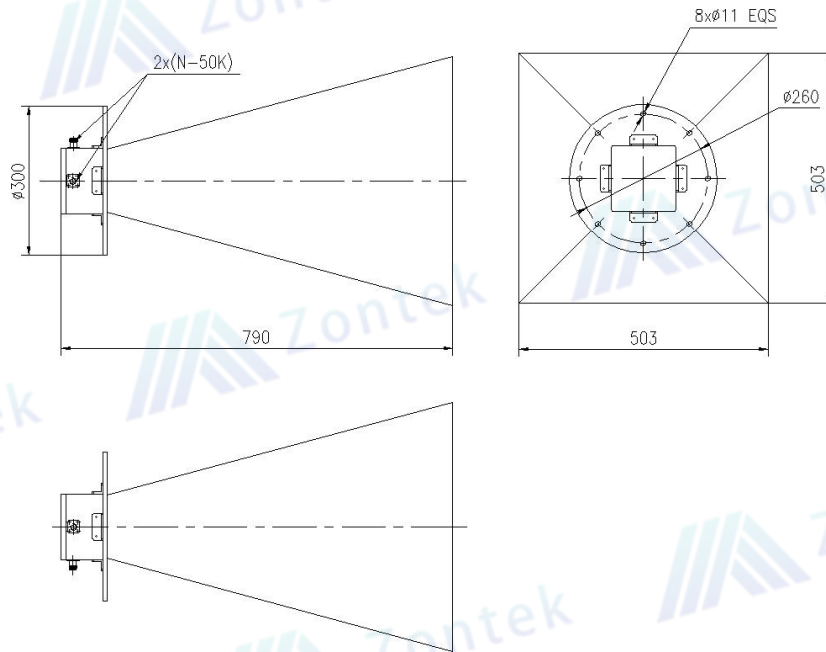

VSWR:

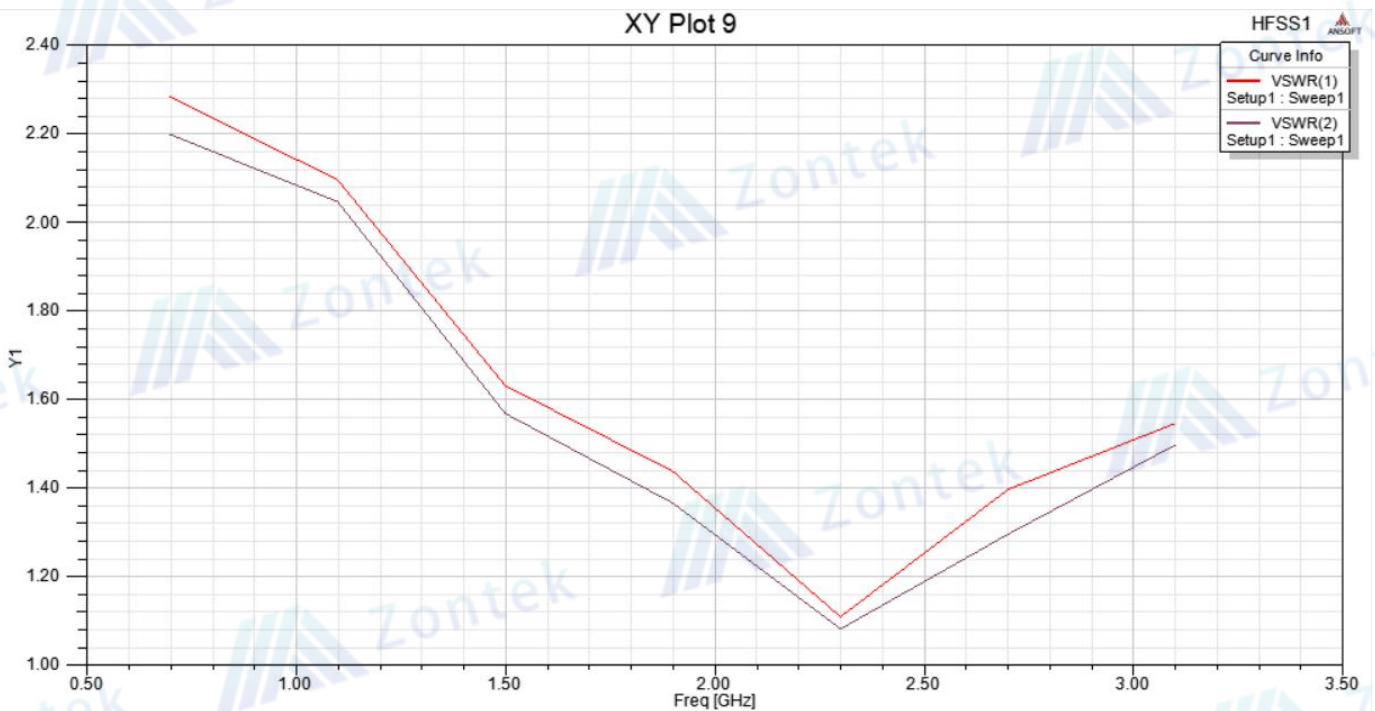



# Chengdu Zontek Technology Co.,Ltd.

Gain:

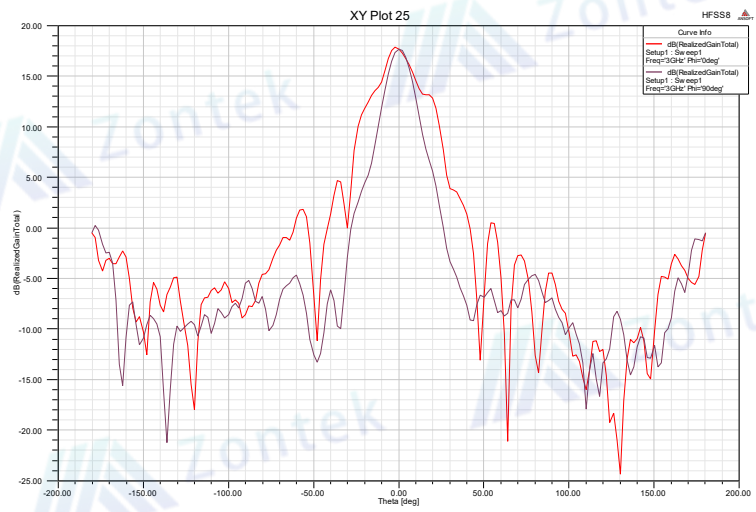
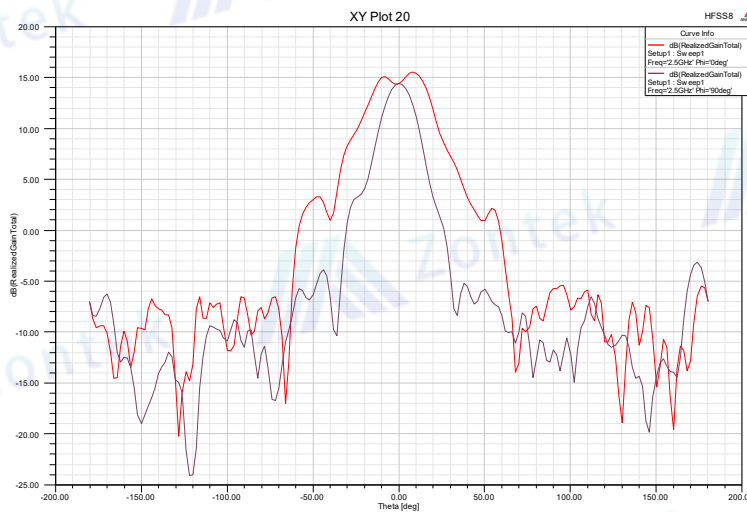
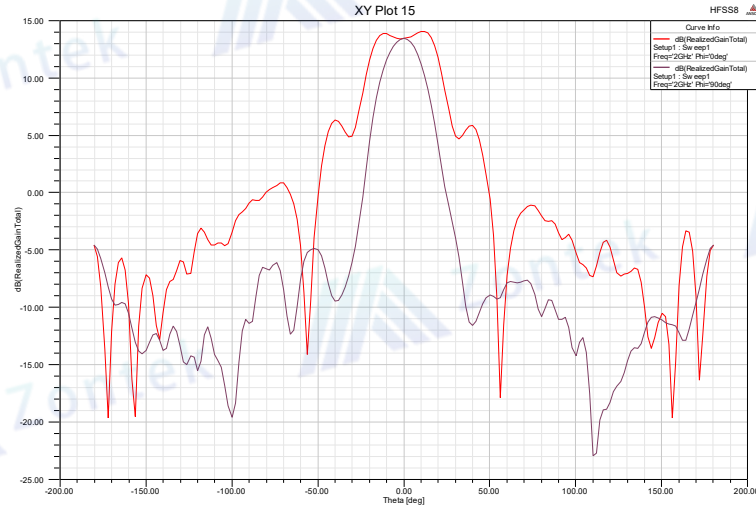
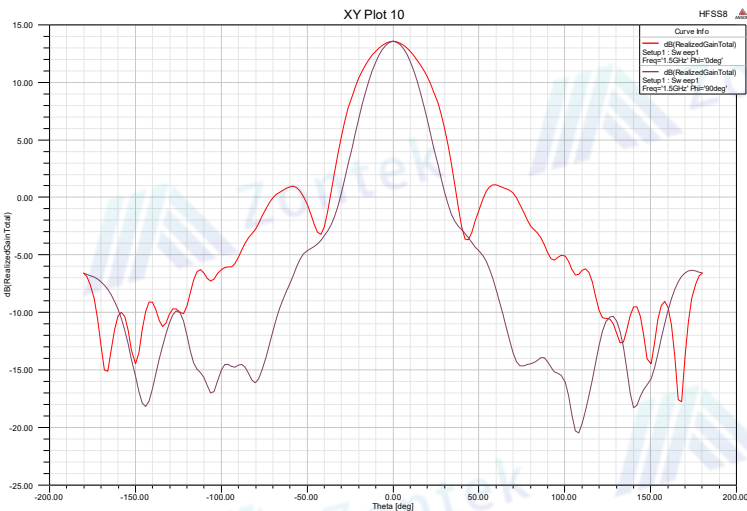
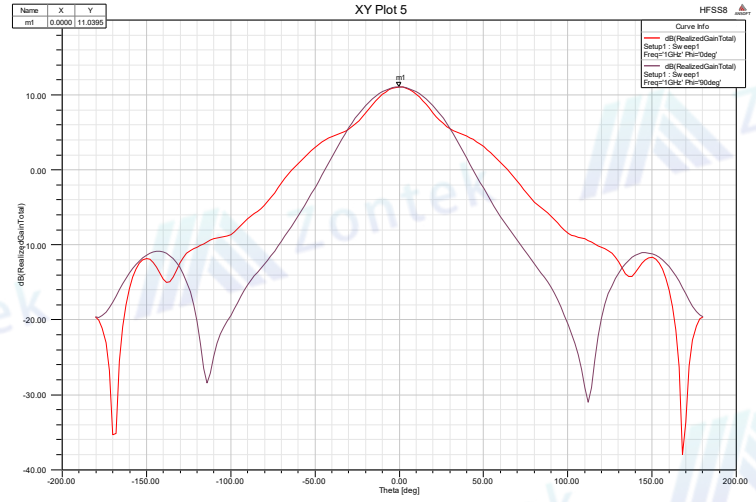
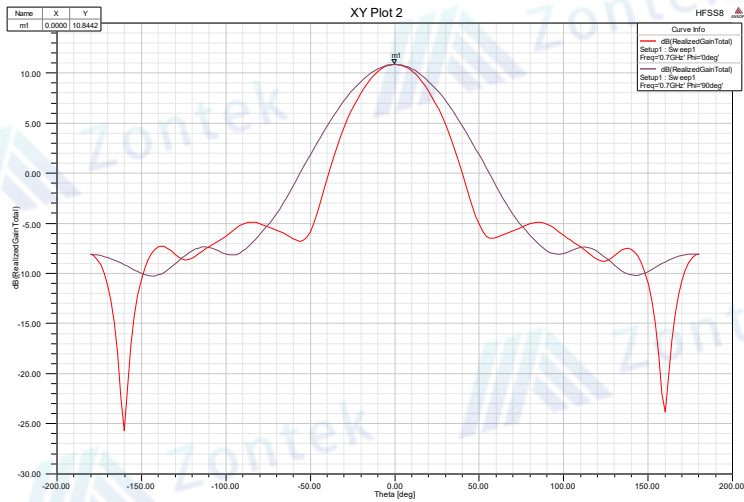

Website: [www.a-microem.com](http://www.a-microem.com) Email: [salesdirector@a-microem.com](mailto:salesdirector@a-microem.com) Tel: (+86) 028-89541190  
Data for reference only, for more information, please contact: [salesdirector@a-microem.com](mailto:salesdirector@a-microem.com)