



Technical Specification		
Standard Gain Horn Antenna		
Item	Specification	Unit
Model	ZK-STLB187-15	
Frequency Range	3.95-5.85	GHz
Gain	15 Typ.	dB
VSWR	1.3 Typ.	
Polarization	Linear	
Beam width of plane E	32°Typ	
Beam width of plane H	31°Typ	
Waveguide	WR187	
Flange	CMR-187	
Material	Al	
Color	Grey(7544C)	
Size	162*133.1*96.9(L*W*H)	mm



Chengdu Zontek Technology Co.,Ltd.

Outline Drawing:

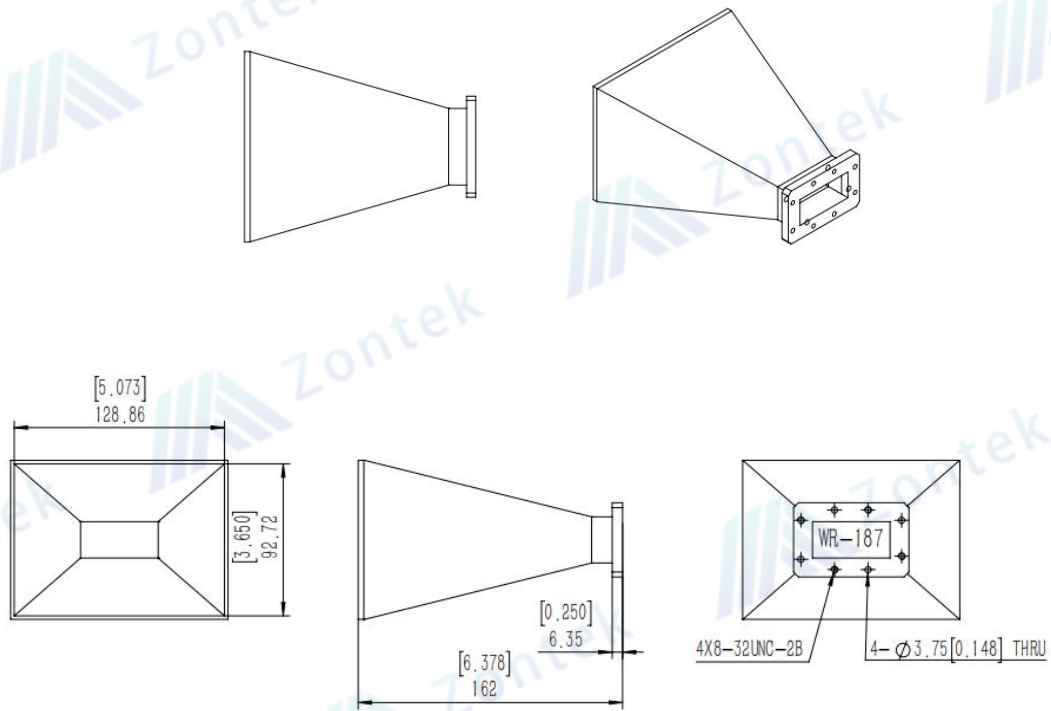

VSWR:

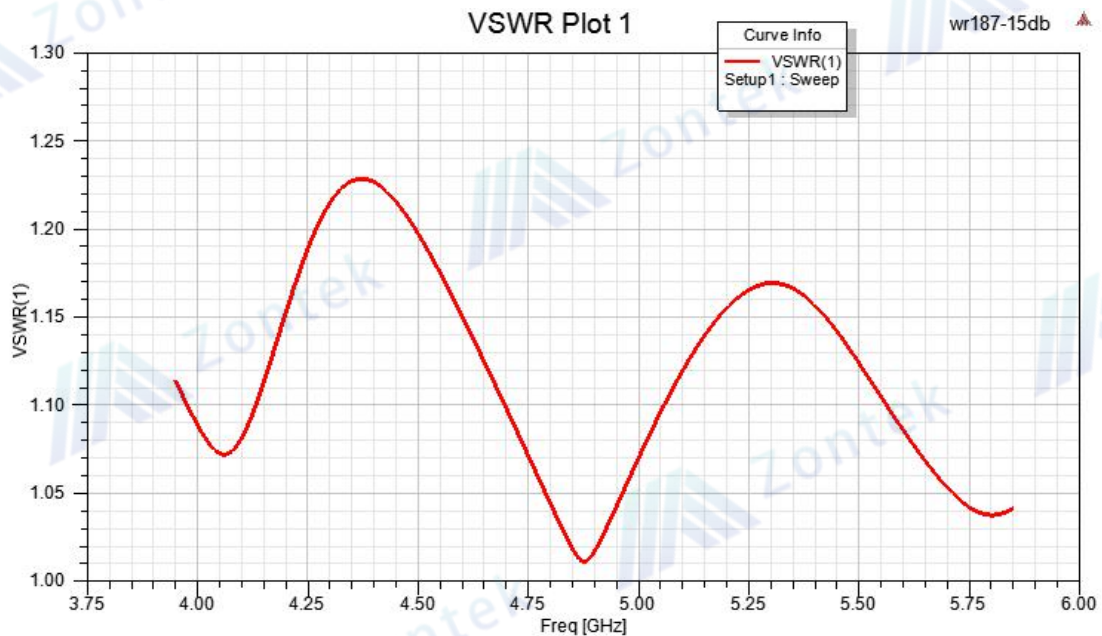



Chengdu Zontek Technology Co.,Ltd.

Gain:

