



Technical Specification		
Standard Gain Horn Antenna		
Item	Specification	Unit
Model	ZK-STLB187-20	
Frequency Range	3.95-5.85	GHz
Gain	20 Typ.	dB
VSWR	1.3 Typ.	
Polarization	Linear	
Beam width of plane E	17.3°Typ	
Beam width of plane H	17.5°Typ	
Waveguide	WR187	
Flange	CMR-187	
Material	Al	
Color	Grey(7544C)	
Size	482*238.63*178.6(L*W*H)	mm



Chengdu Zontek Technology Co.,Ltd.

Outline Drawing:

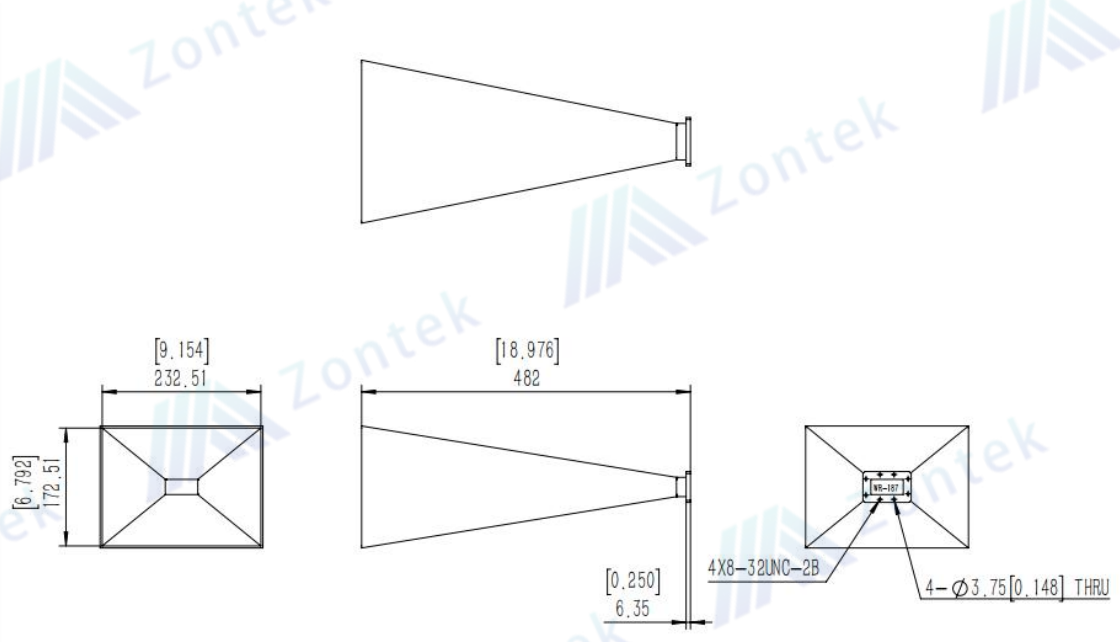

VSWR:

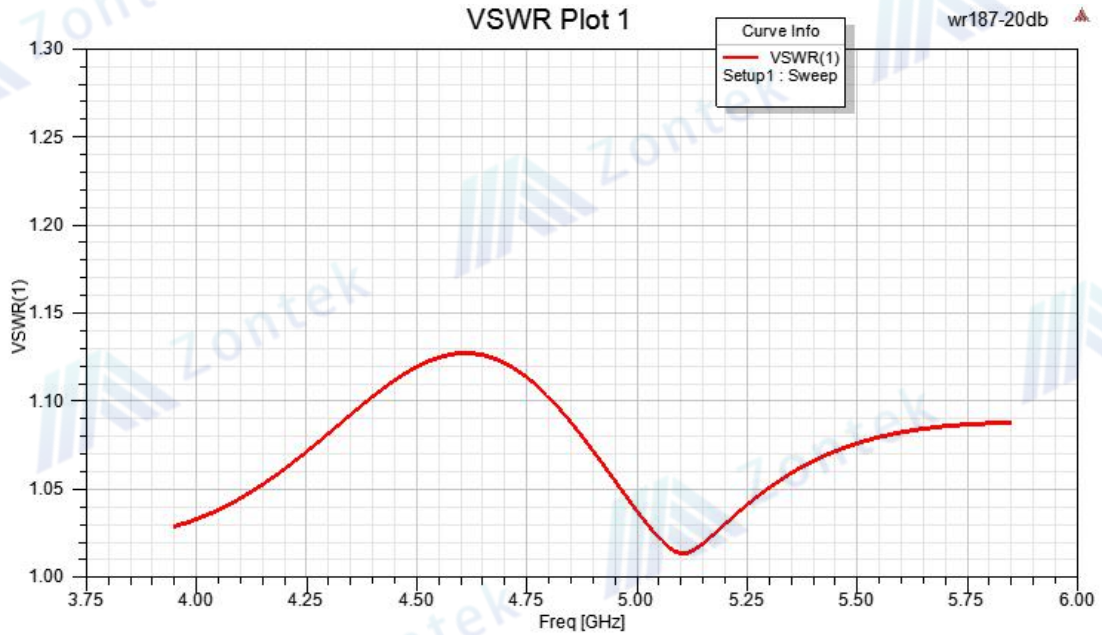



Gain:

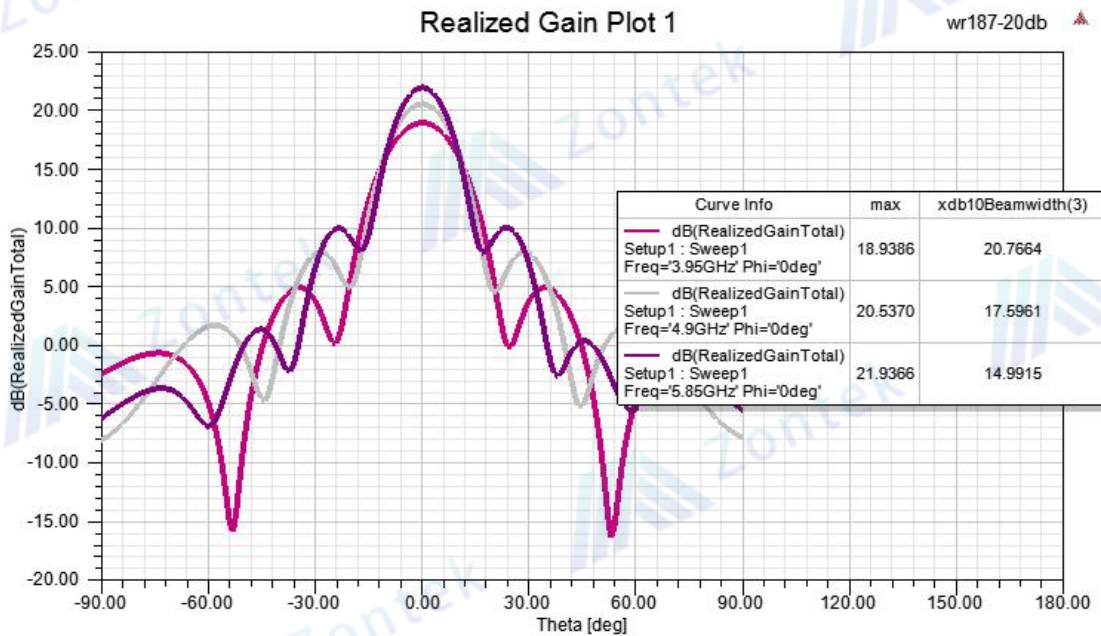
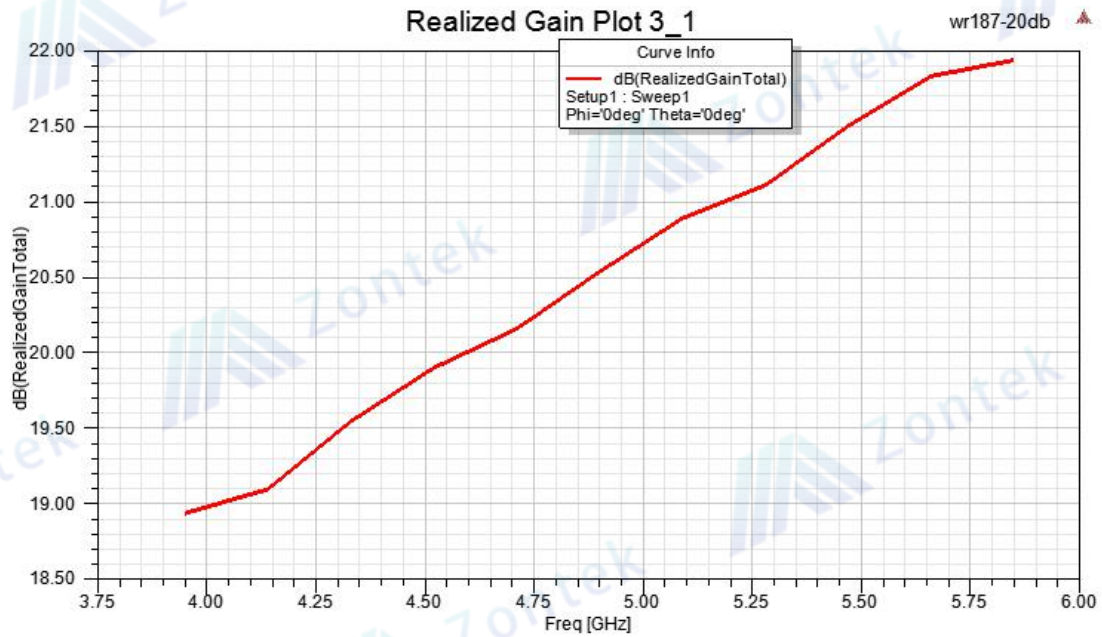



Chengdu Zontek Technology Co.,Ltd.

