



Technical Specification		
Standard Gain Horn Antenna		
Item	Specification	Unit
Model	ZK-STLB229-10	
Frequency Range	3.3-4.9	GHz
Gain	10 Typ.	dB
VSWR	1.3 Typ.	
Polarization	Linear	
Beam width of plane E	51.6°Typ	
Beam width of plane H	52.1°Typ	
Waveguide	WR229	
Flange	CMR-229	
Material	Al	
Color	Grey(7544C)	
Size	105*92.52*75.16(L*W*H)	mm



Chengdu Zontek Technology Co.,Ltd.

Outline Drawing:

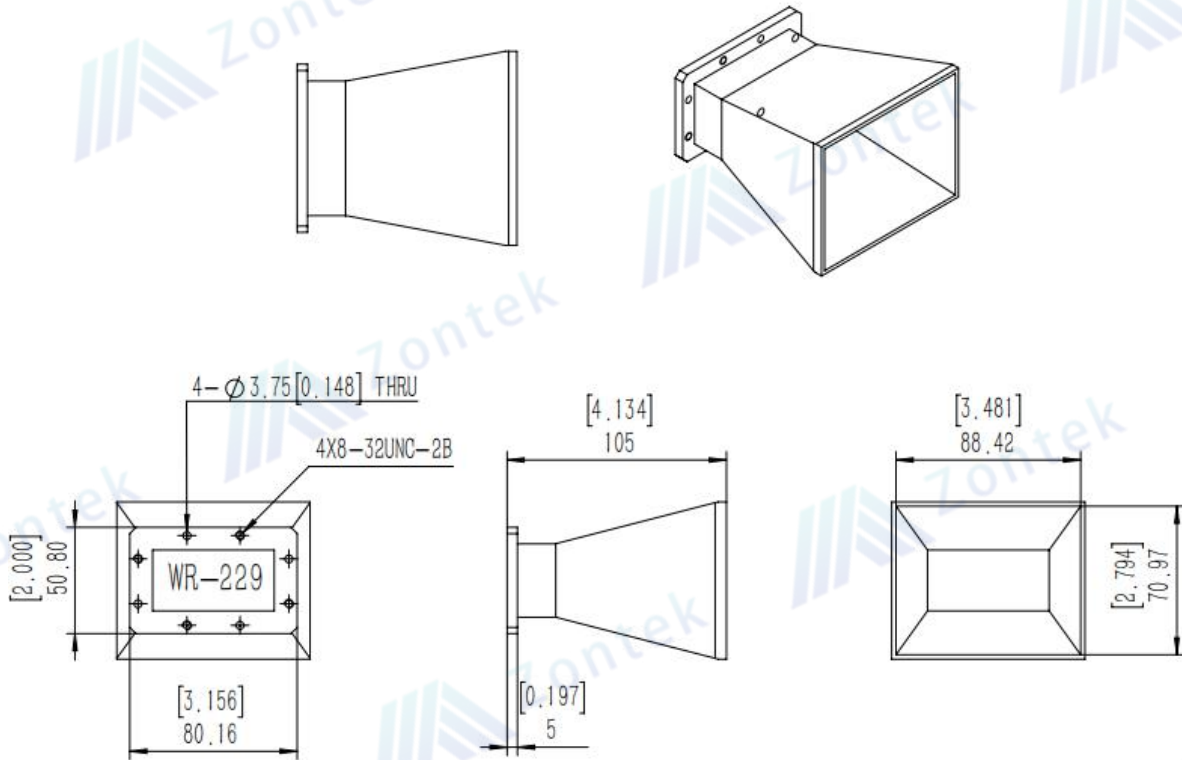

VSWR:

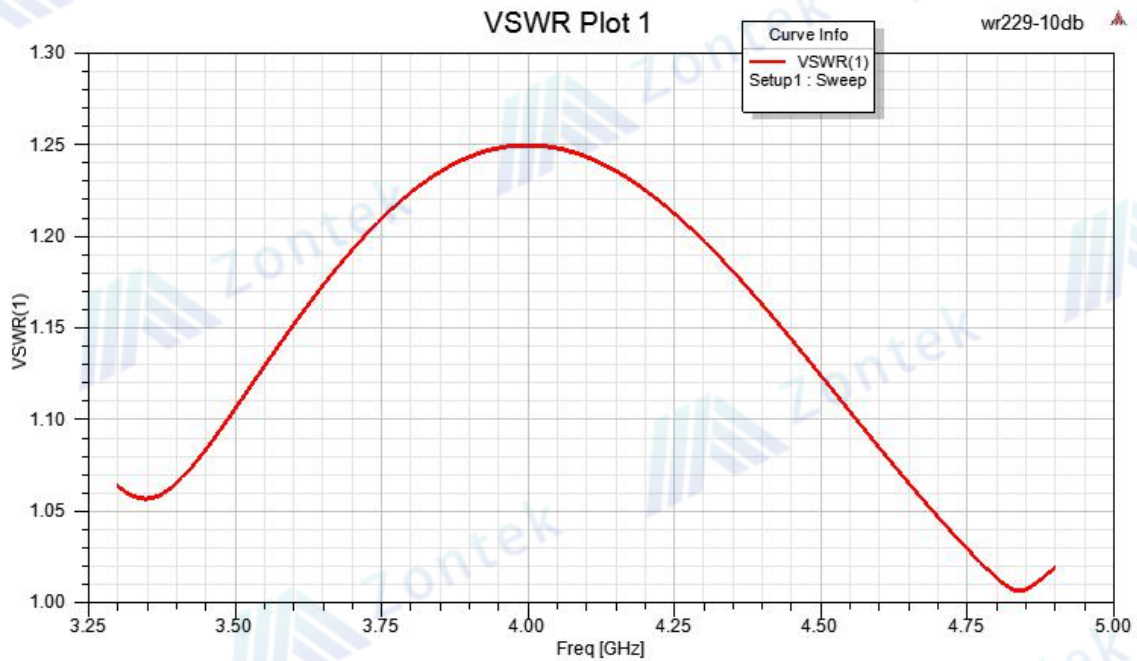



Gain:

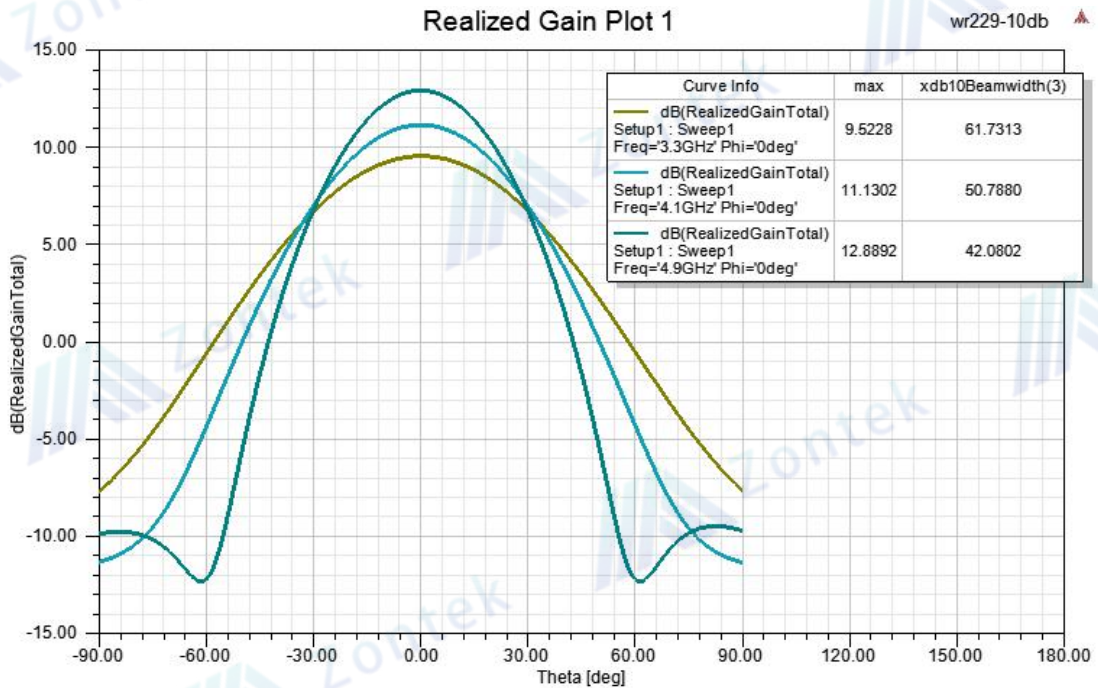
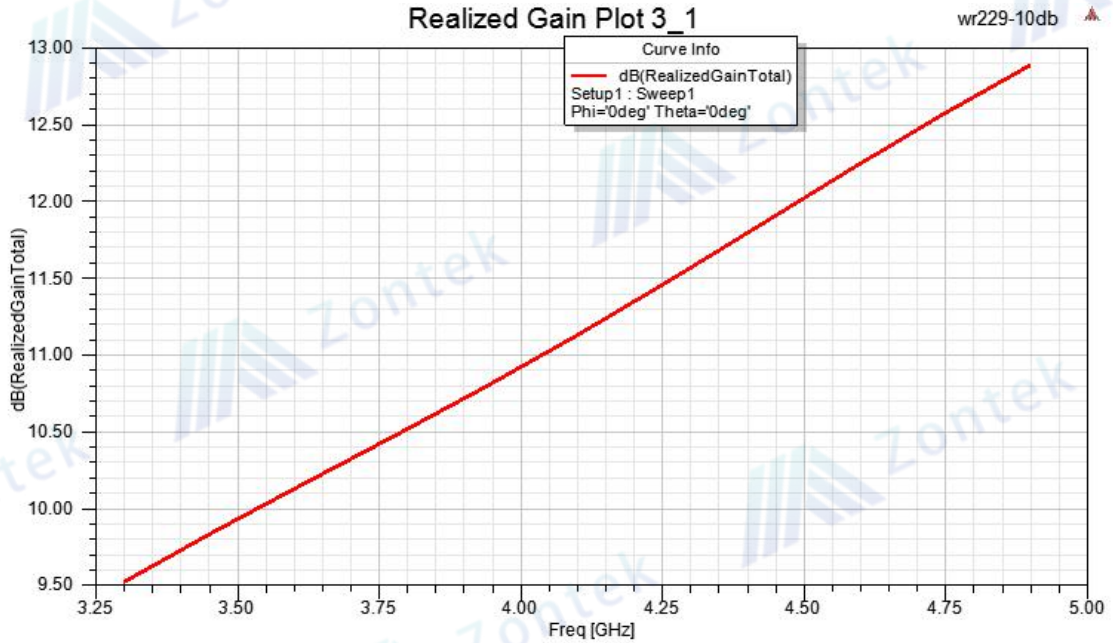



Chengdu Zontek Technology Co.,Ltd.

