



Technical Specification		
Standard Gain Horn Antenna		
Item	Specification	Unit
Model	ZK-STLB284-20	
Frequency Range	2.6-3.95	GHz
Gain	20 Typ.	dB
VSWR	1.3 Typ.	
Polarization	Linear	
Beam width of plane E	17.3°Typ	
Beam width of plane H	17.5°Typ	
Waveguide	WR284	
Flange	CMR-284	
Material	Al	
Color	Grey(7544C)	
Size	730*358.88*267.8(L*W*H)	mm



Chengdu Zontek Technology Co.,Ltd.

Outline Drawing:

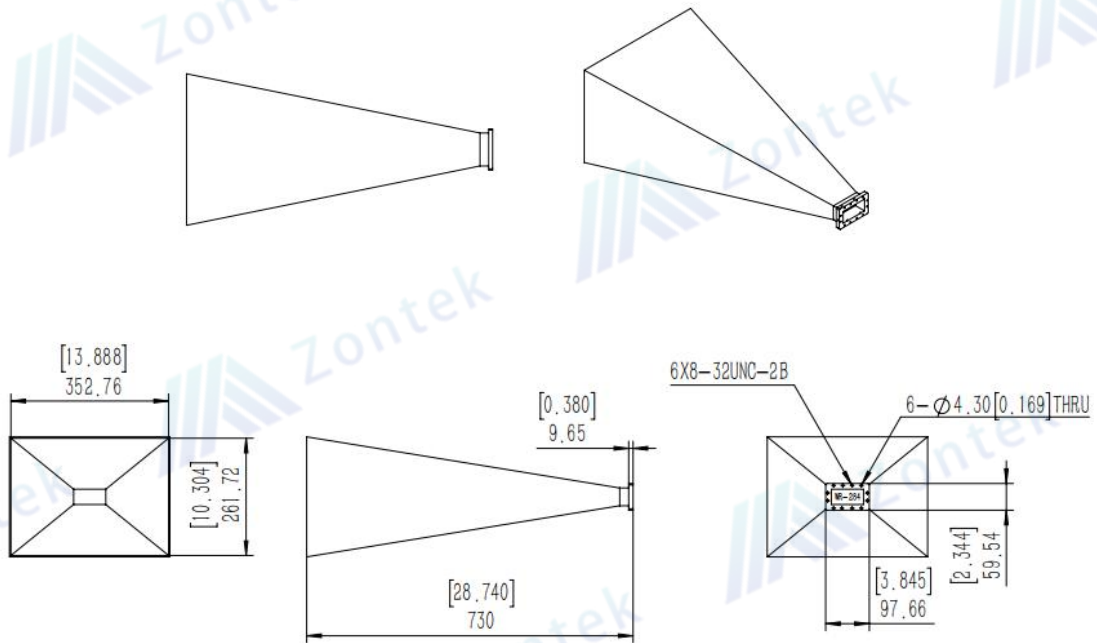

VSWR:

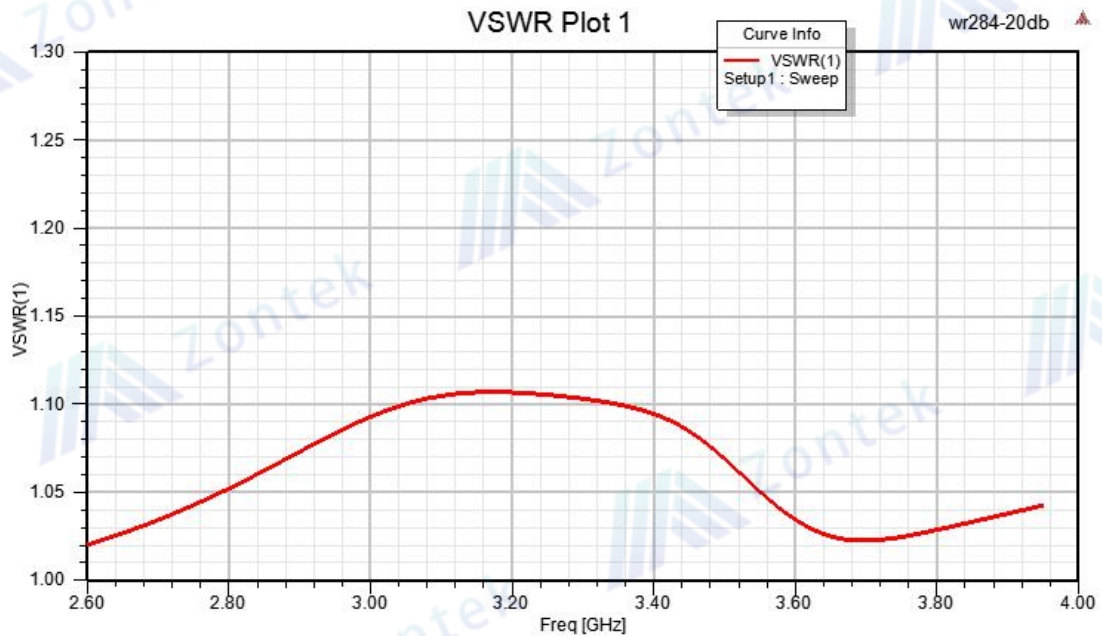



Gain:

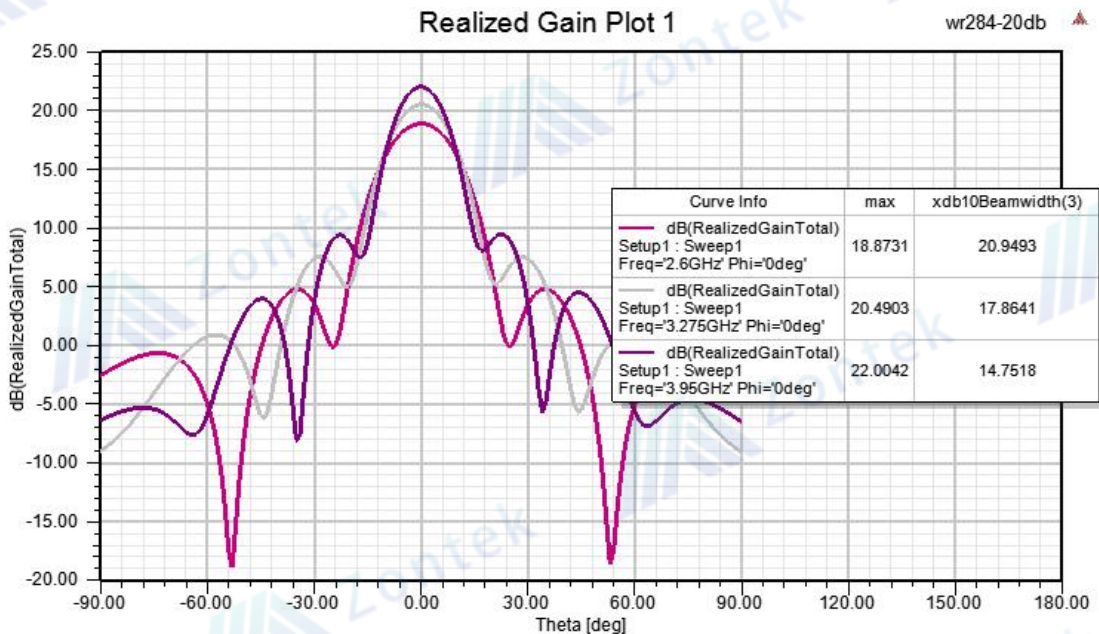
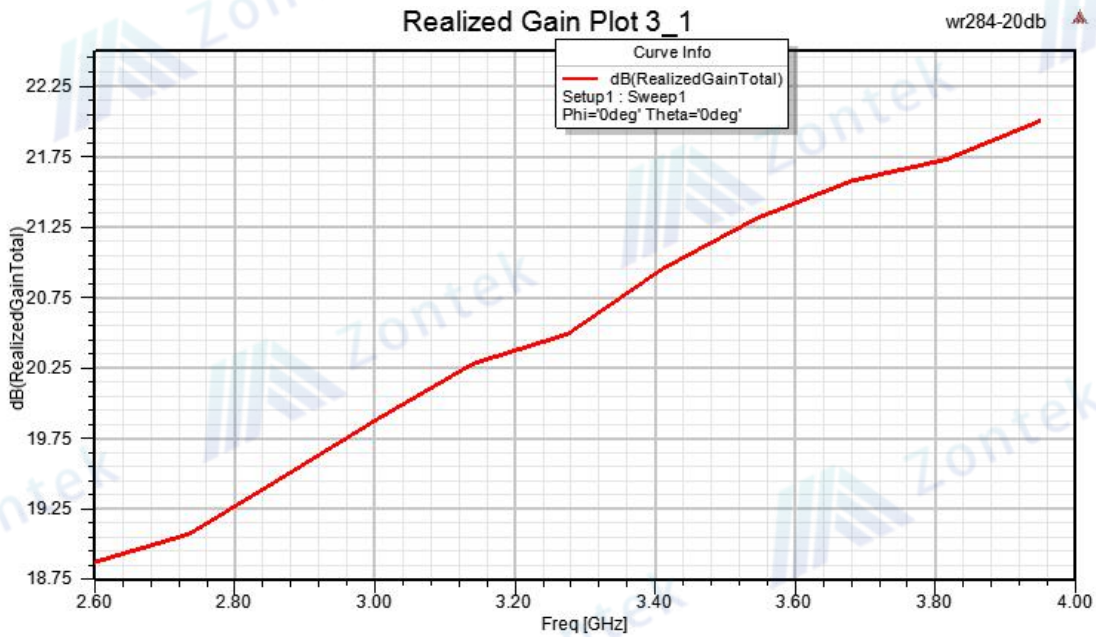



Chengdu Zontek Technology Co.,Ltd.

